

Holland wear patch reduces hardfacing costs and keeps your equipment moving

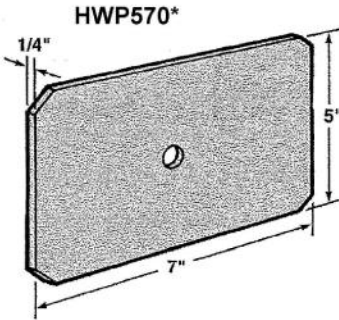

MODERATE IMPACT RESISTANT WEAR PATCH
Applications: Dozer Moldboards and Sidearm; Loader Bucket Side Protection and Bottom between Skids; Impact Resistant Materials including Chutes; Drag Lines; Shovels; Excavators; Truck Beds; Log Forks; and various other applications that are subject to impact.

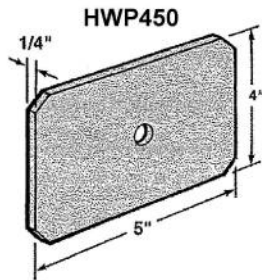

MODERATE IMPACT 45 RESISTANT WEAR PATCH
Applications: Shovel Buckets; Drag Lines; Excavators; Dozers and many other high wear applications subject to impact.

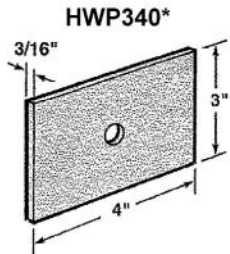

HIGH ABRASION WEAR PATCH
Applications: Loader Bucket Side Protection; Elevating and Push-Pull Scrapers; Crusher Chutes (note: WP-340 will normally crush if worn out because of their hardness); Material Deflector Plates; Drag Lines; Excavators; Paving Machine Chain Covers; Return Guides; Conveyor Troughs; Baffles; Pugmills; Backhoe Buckets and many other applications.

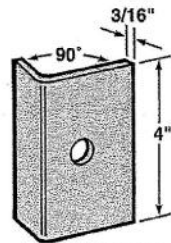
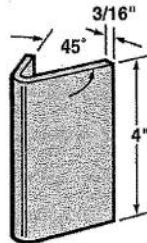

HWP257 HWP258 HIGH ABRASION WEAR LIPS
Applications: Loader Buckets; Vertical Edges; Backhoe, Elevator and Excavator Buckets; Mixing Paddles and many other abrasive applications requiring special angles.

HIGH ABRASION WEAR PATCH HWP154
Applications: Same as HWP340. Smaller width is better suited to fit contoured surfaces such as round troughs or flat surfaces where small area protection is required. WP-154 is ideal for Asphalt Paver Wear Slats.

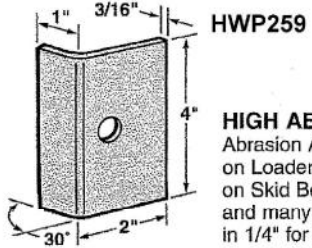
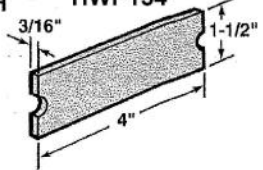

HWP259 HIGH ABRASION BEVEL WEAR LIPS
 Abrasion Applications for Moldboard Adaptors on Loaders, Drag Lines and Shovels. Also fits on Skid Bevels for Mowers, Cultivator Skids and many other applications. Also available in 1/4" for heavy duty applications.

* Also available in high impact 3/8" thickness.

HWP-812-38=3/8x8x12 - 10 lbs

PART NUMBER	DESCRIPTION	THICKNESS	WIDTH	LENGTH	WEIGHT
WP-154	Flat Wear Patch	.1875"	1.50"	4.00"	.32 lbs.
WP-342	Flat Cone Wear Patch	.1875"	2.50-3.00"	4.00"	.58 lbs.
WP-340	Flat Wear Patch	.1875"	3.00"	4.00"	.64 lbs.
WP-450	Flat Wear Patch	.2500"	4.00"	5.00"	1.42 lbs.
WP-570	Flat Wear Patch	.2500"	5.00"	7.00"	2.48 lbs.
WP-340-38	Flat Wear Patch	.3750"	3.00"	4.00"	1.28 lbs.
WP-570-38	Flat Wear Patch	.3750"	5.00"	7.00"	3.72 lbs.
WP-254	30 deg. Bucket Lip	.1875"	2.50"	4.00"	.74 lbs.
WP-255	RH Corner Bucket Lip	.1875"	2.75"	5.25"	.86 lbs.
WP-256	LH Corner Bucket Lip	.1875"	2.75"	5.25"	.86 lbs.
WP-257	45 deg. Bucket Lip	.1875"	2.50"	4.00"	.80 lbs.
WP-258	90 deg. Bucket Lip	.1875"	2.50"	4.00"	.64 lbs.
WP-259	30 deg. Moldboard Lip	.1875"	2.50"	4.00"	.60 lbs.
WP-259-HD	Heavy Duty 30 deg. Mold.	.2500"	2.50"	4.00"	.80 lbs.

HOLLAND EQUIPMENT COMPANY
 2870 WEST 2100 SOUTH
 SALT LAKE CITY, UTAH 84119
 (801) 972-1601 WWW.HOLLANDEQ.COM